



GEARGRID Wall Mount Storage Locker

Assembly Instructions & Owner's Manual

Thank you for choosing the GearGrid Wall Mount Storage Locker. GearGrid is committed to high-quality products and your complete satisfaction.

Please read this manual before you start the assembly. Call us at 888-643-6694 if you need technical assistance or encounter product performance questions along the way.

Before You Begin:

- Observe all local building codes
- Check placement; avoid drilling into plumbing and electrical wires.

NOTE: Two person assembly is required

Tools Required:

- Rubber mallet
- 7/16", 1/2", 9/16" sockets with ratchet
- Drill with 3/8" masonry bit or 1/4" wood bit
- Chalk line
- Tape measure
- Level

Hardware Required (not supplied):

- For wood walls - 3/8" x 2" lag screws
- For concrete walls - 3/8" x 1-7/8" sleeve type anchor bolt

Assembly Preparation:

- Open and remove contents from all boxes
- Check all parts against the parts list
- Organize parts by type
- Locate a clear, level floor
- Lay the shipping carton cardboard on the floor and assemble the unit on it for protection during assembly.



Safety Installation Tips:

- Always wear safety glasses and safety shoes when assembling GearGrid Lockers.
- Some assembly steps require that two or more persons work together since some components are difficult to handle alone.
- Inferior or improperly installed fasteners could cause sudden collapse of the locker system.
- Never place more than 100 lbs. on a single shelf.
- Never hang from or climb on lockers.
- Overloading or shock-loading lockers could cause a collapse, resulting in property damage or serious injury.



THANK YOU FOR CHOOSING GEARGRID for smarter, stronger, storage solutions. Setting the standard for craftsmanship, quality and service.

For general parts or assembly assistance: 651-464-4468 or toll free 888-643-6694

For accessory inquiries: sales@geargrid.com or 651-464-4468, toll free 888-643-6694

For our versatile product line, specifications and resources for custom solutions: www.geargridcorp.com

670 SW 15th Street, Forest Lake, MN 55025 | Toll Free: 888-643-6694 | 651-464-4468 | Fax: 651-464-4780
sales@GearGrid.com | www.geargridcorp.com

Wall Mount Storage Locker Overview

GearGrid Wall Mount Lockers can be ordered in a variety of different “run” configurations. A “run” is simply the number of locker openings that exist in a configuration. Each “run” is assembled and installed in sets of 2 or 3 lockers, beginning with a “starter” set of lockers, and continuing with subsequent “extension” sets of lockers. These instructions will walk you through, step by step, how to install any configuration that has been ordered. The parts that will be needed for any standard Wall Mount Locker “run” are shown below. The quantity of each part included with your order will depend on your configuration. GearGrid recommends assembly of system from left to right.

Standard Wall Mount Locker Parts

① WALL MOUNT BRACKET
*1 used at every locker top & bottom
see Page 8, Step 2c

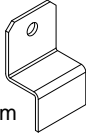

② 1/4-20 x 5-1/2" BOLT

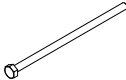

③ 1/4" FLAT WASHER



⑤ WEDGE NUT

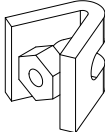

⑬ 1-1/4" SQ. PLUG
16 GAUGE

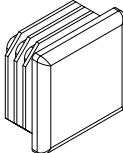

④ 2-START TUBE



3-START TUBE

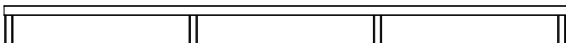

⑪ BACK PANEL

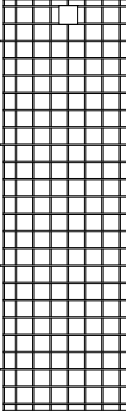

⑮ STANDARD SIDE

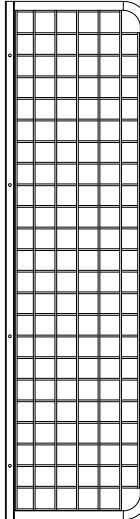

2-EXTENSION TUBE



3-EXTENSION TUBE

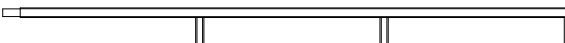

Examples of Start and Extension Tubes Used in Locker Configurations

****Note - 2 Wall Mount Brackets are used at every locker. 1 at the top & 1 at the bottom, see page 8, Step 2c

FOUR LOCKERS

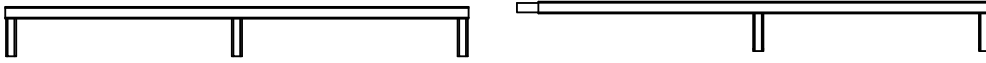

FIVE LOCKERS

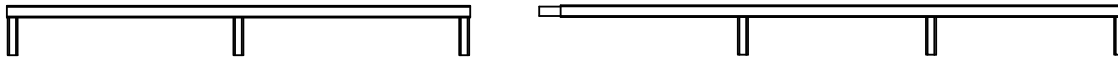

SIX LOCKERS

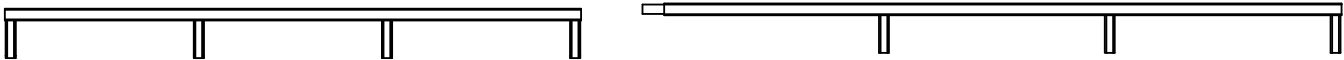

SEVEN LOCKERS

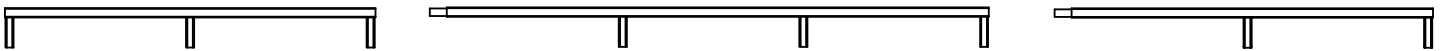

EIGHT LOCKERS

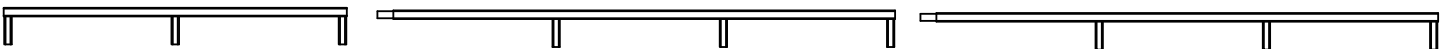

NINE LOCKERS

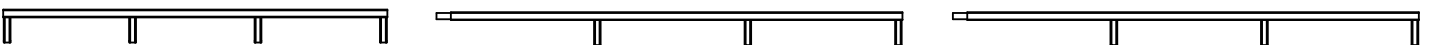

NOTE: When locker configuration is not divisible by three, begin with a 2-start tube.

Optional Door Parts*

*Applicable if you ordered these accessories.

⑫ DOOR

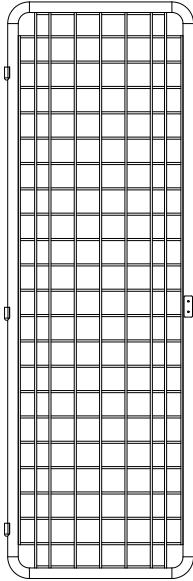

⑧ SIDE, HINGES

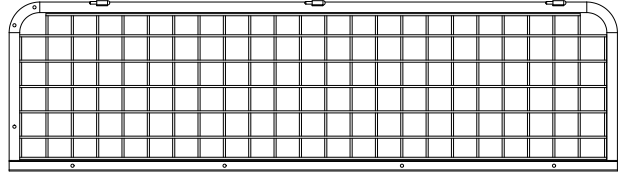

⑨ SIDE, HASP AND HINGE

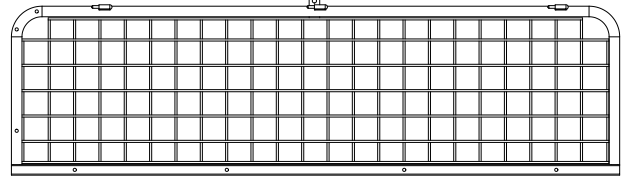

⑥ TOP

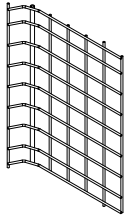

⑩ SIDE, HASP

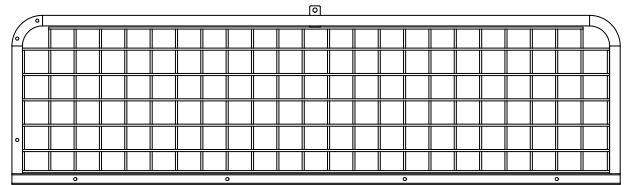

⑦ BRASS BUSHING



⑬ DOOR HASP

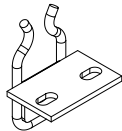

⑭ 1/4-20 x 3/8" BUTTON HEAD SCREW



Wall Mount Storage Locker Parts Diagram

EXPLODED VIEW WITHOUT DOORS

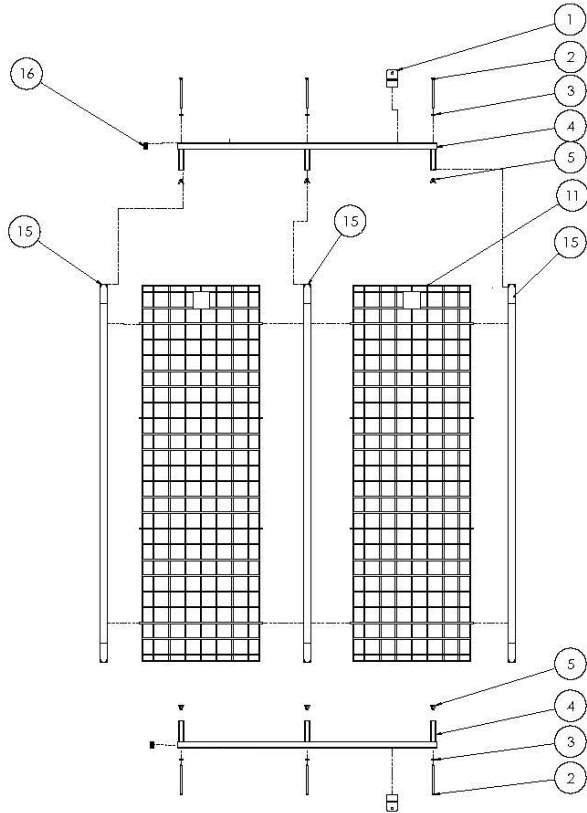

2-STARTER SET OF LOCKERS WITH DOOR OPTION

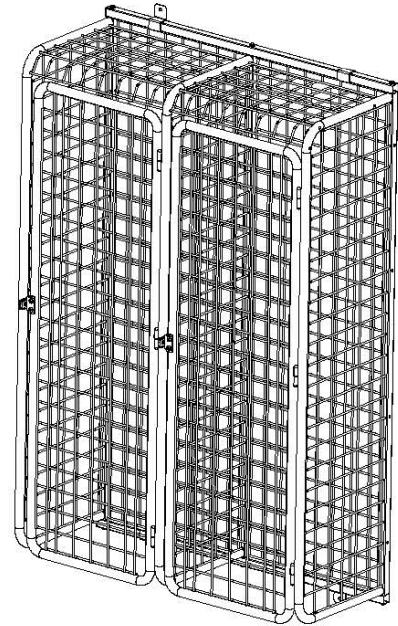

EXPLODED VIEW WITH DOORS

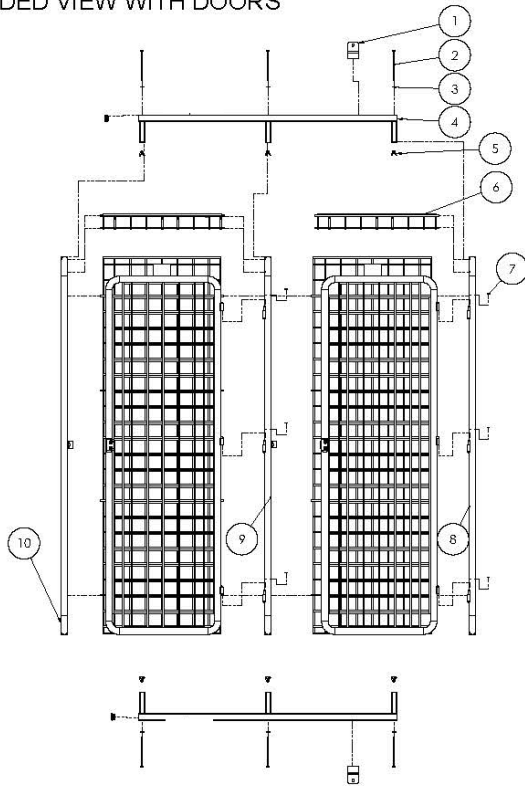

EXPLODED SIDE VIEW WITH DOORS

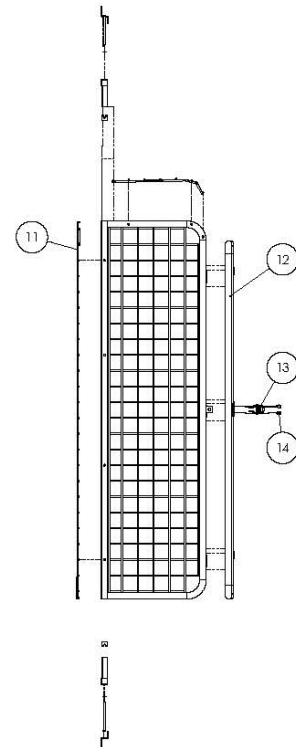

Assembly

- 1) Assemble Start Lockers
- 2) Chalk Line
- 3) Install Bottom Wall Mount Brackets
- 4) Install Start Lockers / Top Wall Mount Brackets
- 5) Assemble Extension Lockers
- 6) Install Extension Lockers To Start Lockers / Top Wall Mount Brackets
- 7) Shelf and Apparel Hook Installation
- 8) Optional Door Installation

****Note - 2 Wall Mount Brackets are used at every locker. 1 at the top & 1 at the bottom, see page 8, Step 2c

1) Assemble Start Lockers

Step 1a: Locate the following items: start tubes (they can be 2-start or 3-start dependant on the size of the run), wedge nuts, 1/4-20 x 5-1/2" bolts, 1/4" flat washers. Install the bolt with the washers through each start tube into the U-channels and thread on the wedge nuts as shown. **WEDGE NUTS MUST BE ORIENTATED AS SHOWN.** Do not tighten bolts at this point. One start tube forms the bottom of your set of lockers, and one start tube forms the top. If installing Power Bar starts and extensions, follow the same procedure using 1/4-20 x 8" bolts.

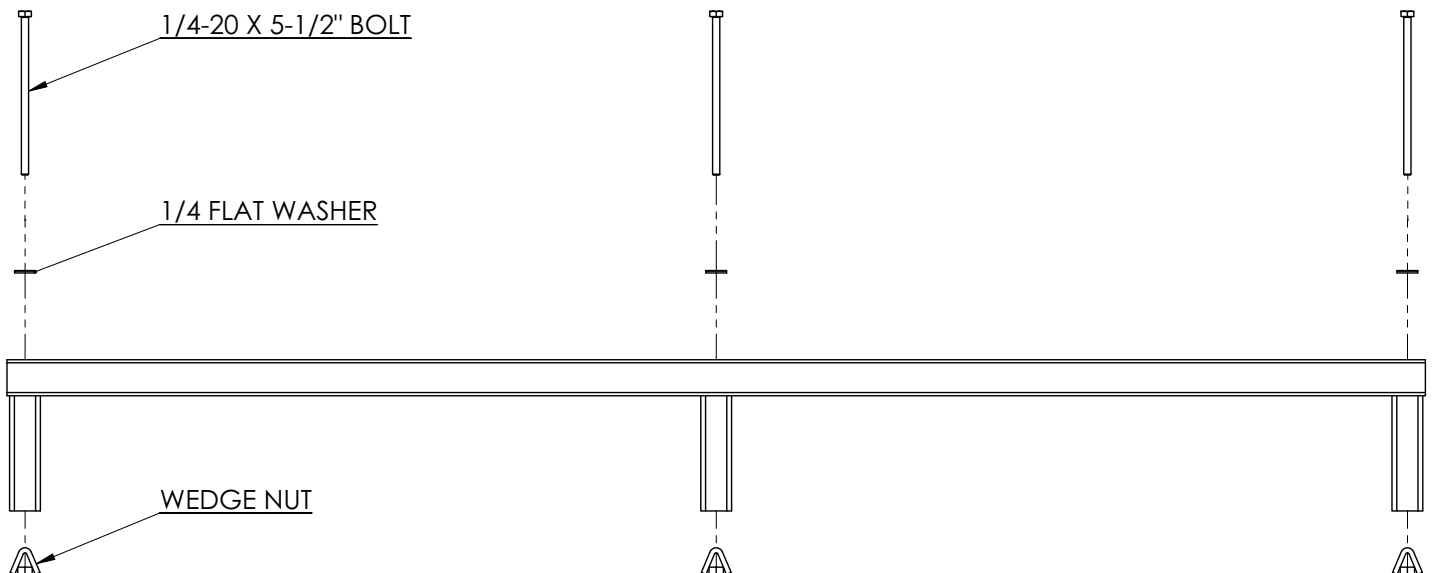

1) Assemble Start Lockers (cont.)

Step 1b: Locate the side panels. If your run does not have doors, use all standard sides. If your run has doors, see NOTE below concerning orientation. Position sides as shown with the short horizontal wires always facing to the right. Slide the bottom and top start tube U-channels into the side panel as shown in the diagram below. **Ensure the side panels short wires are always facing right, the shelves will not fit properly if sides are oriented incorrectly.**

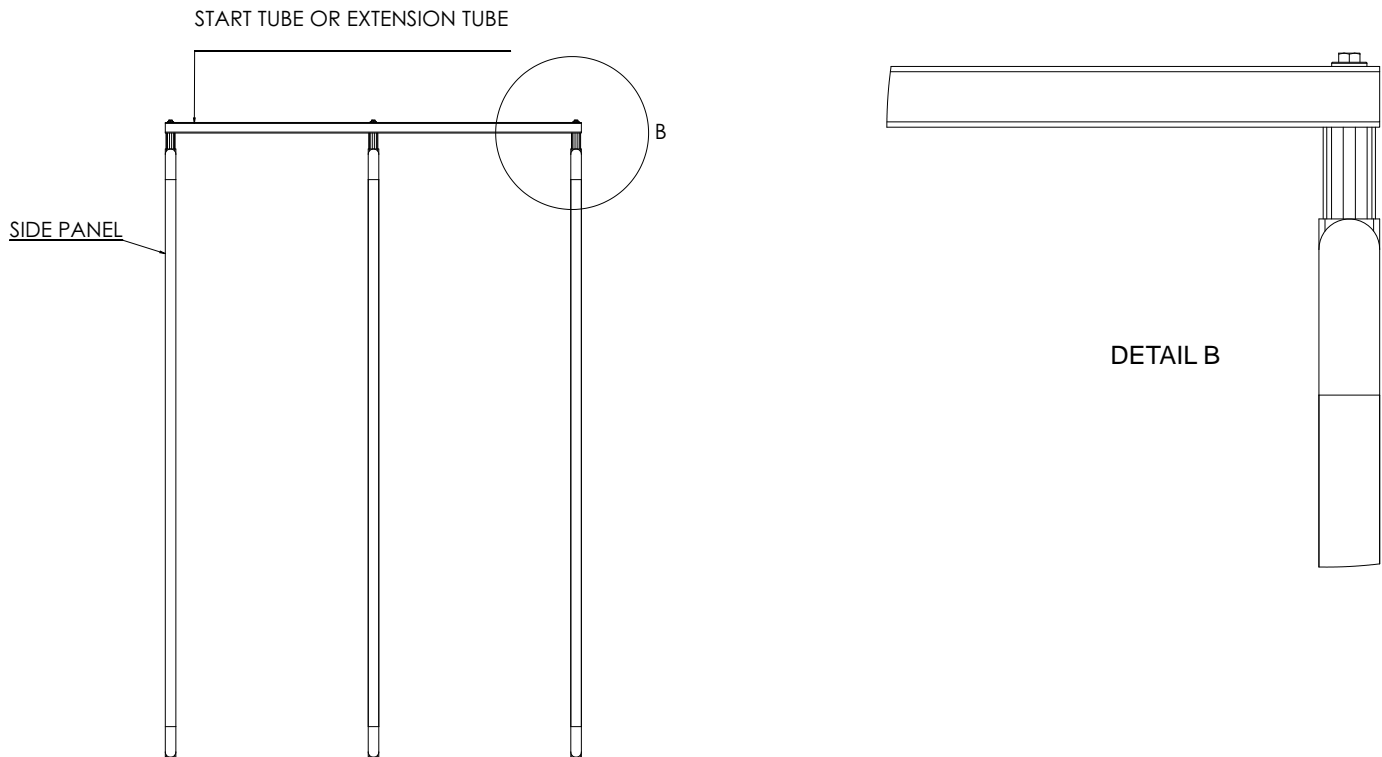

NOTE: When assembling groups of lockers with doors, the side panel on the left end of the starter set of lockers will have only a hasp mounted to it. The right end side panel of the final extension set of lockers will have only hinges mounted to it. Everything in the middle will have both. See diagram below.

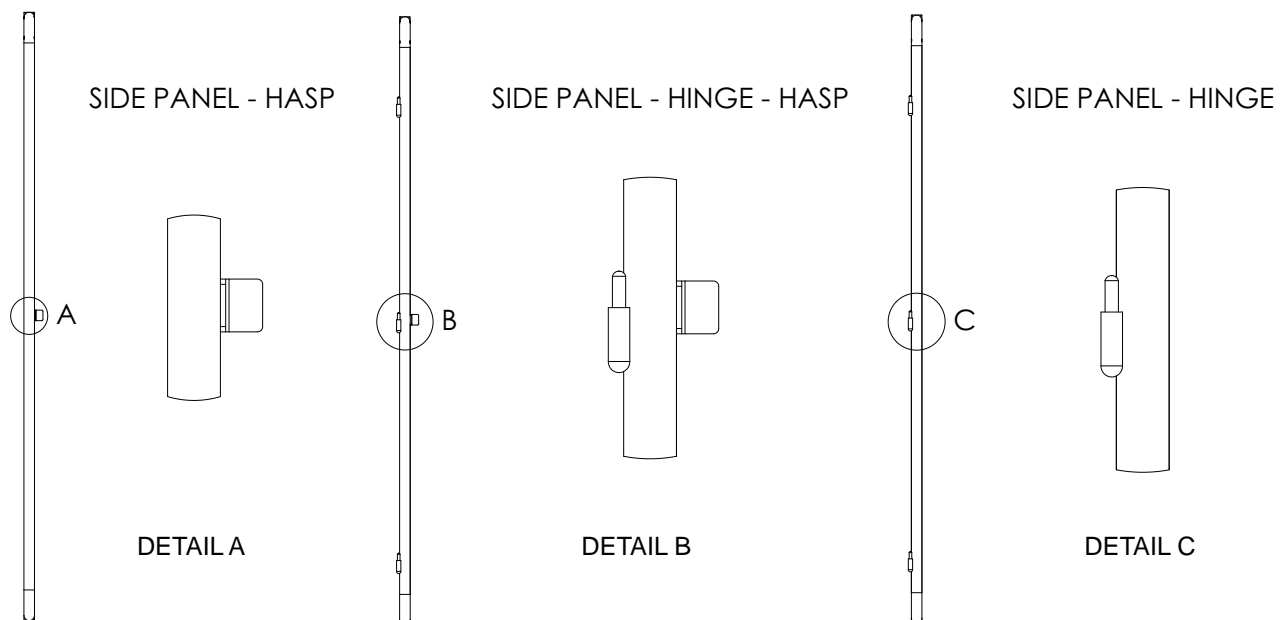

1) Assemble Start Lockers (cont.)

Step 1c: Back panel installation. Locate 2-3 back panels (depending upon whether your run started with a 2-start tube or a 3-start tube). Set the back panels into position with the GearGrid logo at the top and the short horizontal wires facing up as shown in the diagram below. Place the long ended wires into the side tubes as shown in the diagram below. If the unit was ordered with doors and hoods, insert the hood the same way the back panel was installed.

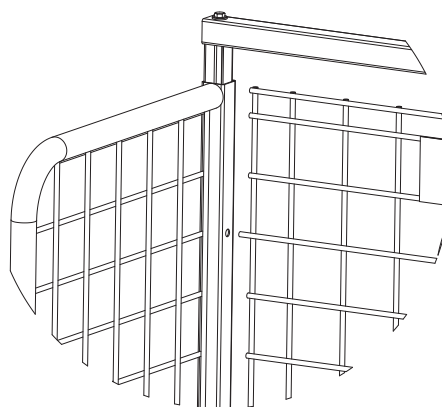
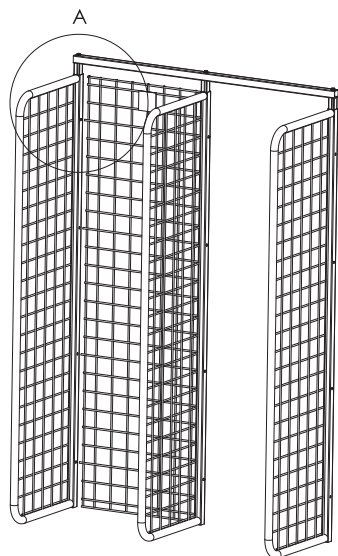

DETAIL A

****Note - 2 Wall Mount Brackets are used at every locker. 1 at the top & 1 at the bottom, see page 8, Step 2c

Step 1d: After sides and optional hood are installed, push the start tubes flush to the side panels square tube and tighten the bolts.

2) Chalk Line

Step 2a: Measure up 8" from floor and mark a point on each end of the wall where lockers are to be located. Snap a chalk line between these two points.

Step 2b: Determine the location of the beginning of the run. Measure from this point the width of the locker opening that was ordered (Ex: 18", 20", 24") and mark points along the chalk line continuing to the end of the locker run. These marks indicate the location of the side panels. Holes for the mounting brackets should NOT be drilled within 1-1/2" of these marks if possible.

Step 2c: Mounting brackets should be placed at the top and bottom of each locker. In wood wall construction, lag screws must be fastened into wooden studs. In concrete block wall construction, anchor bolts should be placed in the web (non-hollow) area for ultimate strength. For steel studs, use a 2" x 6" backer for the top and bottom of your run, or 3/4" plywood behind the locker system. Mark your hole locations along the chalk line.

Step 2d: Drill either a 1/4" diameter hole for wood construction or a 3/8" diameter hole for concrete construction at the points marked in step 2c.

3) Install Bottom Wall Mount Brackets

Step 3: Install the lower wall mounting brackets in the holes drilled on the chalk line. Keep the open end of the bracket facing up.

4) Install Start Lockers

Step 4a: Lift the first assembled start locker unit up and set the bottom start tube into the mounting brackets along the chalk line. Adjust the position of this unit left or right until the end of the locker is in the desired location.

Step 4b: Place a mounting bracket on the top start tube directly above the lower bracket if possible. Mark hole location, drill hole and install bracket. Tighten both upper and lower brackets firmly.

5) Assemble Extension Locker

Step 5: FOLLOW STEP 1A THROUGH 1D AND REPLACE START TUBES WITH EXTENSION TUBES.

6) Install Extension Locker to Start Locker

Step 6: Install assembled locker extensions per the diagram below. Lift assembled extension unit so the bottom extension tube is on the bottom set of wall mount brackets. Carefully slide the extension tubes into the top and bottom start tubes of the installed section. **NOTE: ENSURE THE BACK PANEL LONG WIRES INSTALL INTO THE HOLES ON THE SIDE PANEL SQUARE TUBES.**

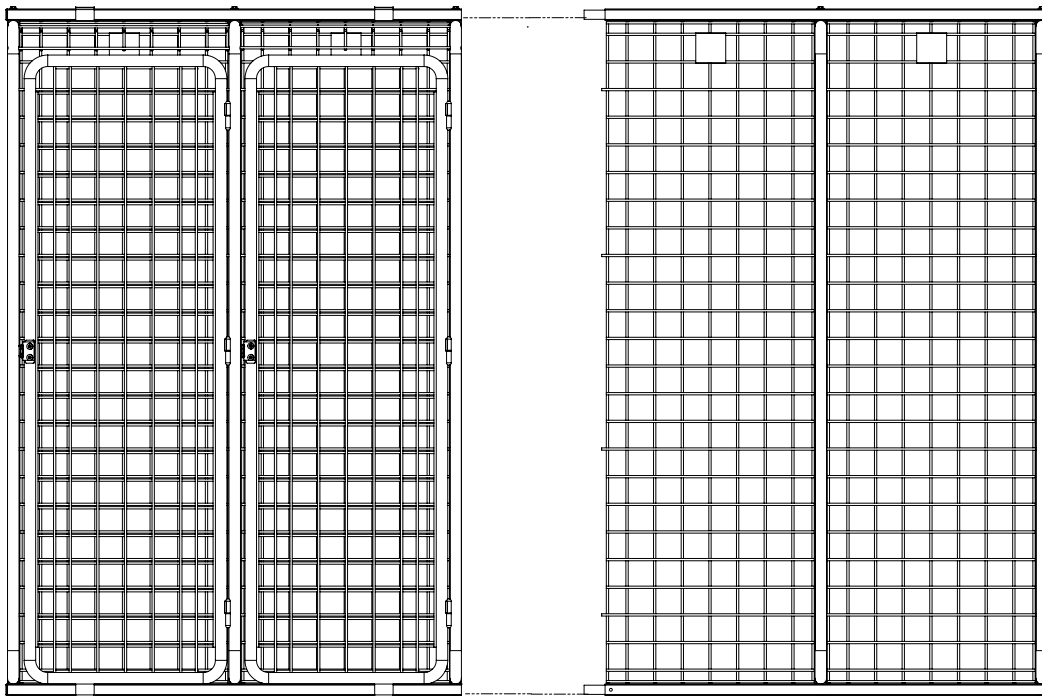

Using a rubber mallet join sections together. Repeat step 4b and install mounting brackets. Repeat step 6 for the remaining assembled locker extensions.

****Note - 2 Wall Mount Brackets are used at every locker. 1 at the top & 1 at the bottom, see page 8, Step 2c

7) Shelf and Apparel Hook Installation

Step 7a: Install the shelves into the unit as shown in the diagrams below. The hooks on the shelves get placed over the horizontal wires on the side panels. The left side hook will be placed behind the first vertical side panel wire. The right side shelf hook will be placed in front of the first vertical wire.

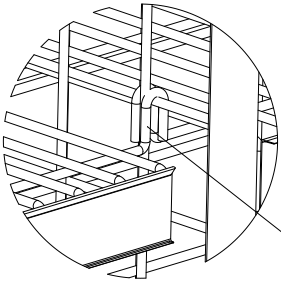
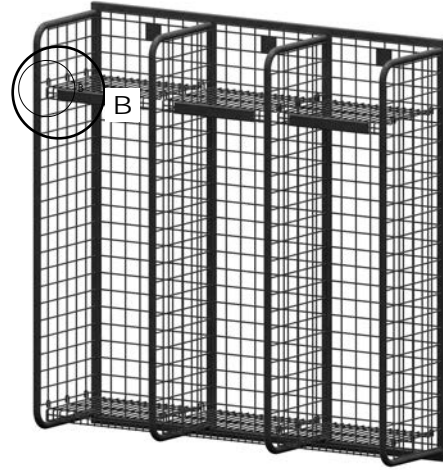
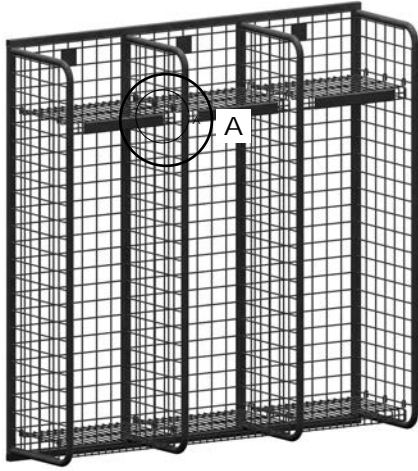

DETAIL A

RIGHT SIDE OF SHELF
THE SHELF WIRE GOES IN FRONT
OF FIRST VERTICAL WIRE

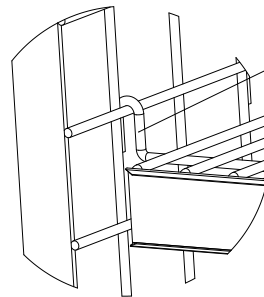

LEFT SIDE OF SHELF
THE SHELF WIRE GOES BEHIND
THE FIRST VERTICAL WIRE

DETAIL B

Step 7b: Install the apparel hooks as shown in the diagram below. Squeeze the ends of the hook and place in desired location.

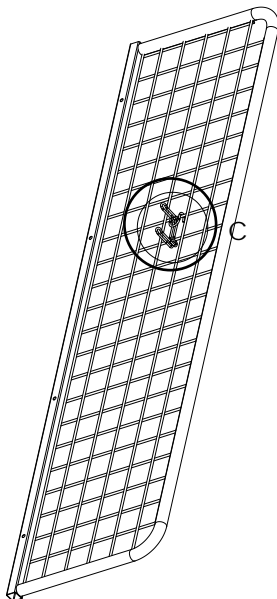

DETAIL C

SQUEEZE THE
TWO ENDS OF
THE APPAREL
HOOK TO
INSTALL TO
GRID

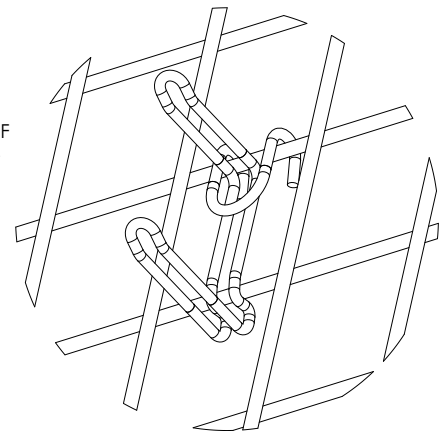

8) Optional Door Installation*

*Applicable if you ordered these accessories.

Step 8a: Install the brass bushings on all hinges located on the side panels as shown below.

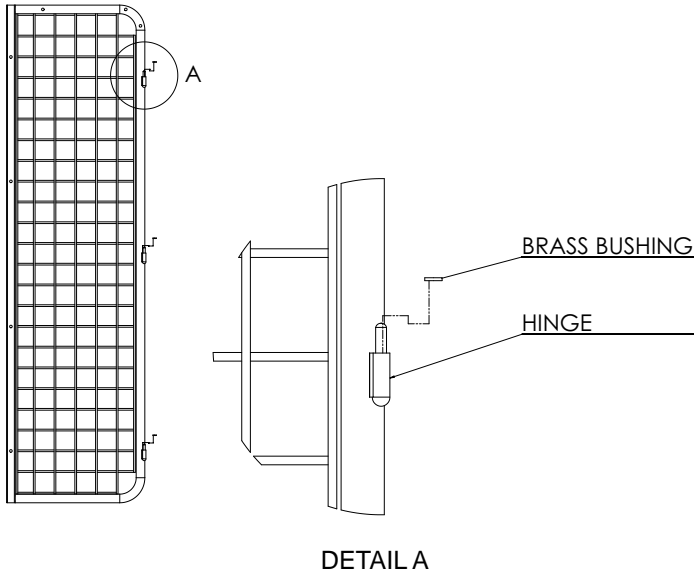

Step 8c: Install the door hasps finger tight using the supplied 1/4-20 x 3/8" button head screws as shown below. Close the door to align position of the hasp and then tighten the screws with an allen wrench.

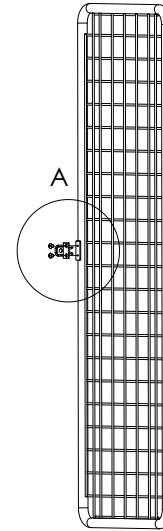

Step 8b: Install doors over the hinges as shown in the diagram below

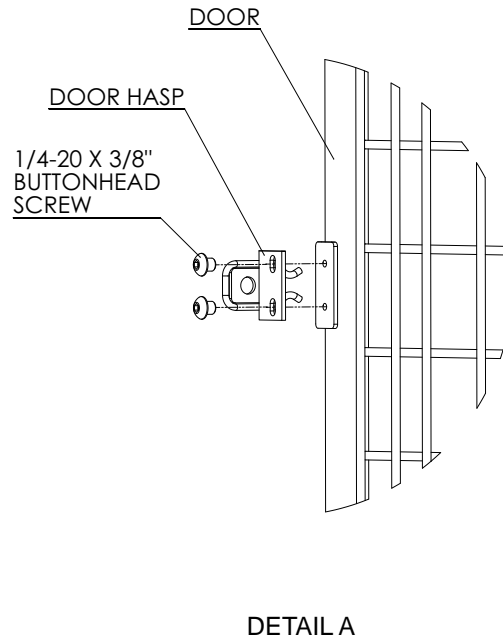
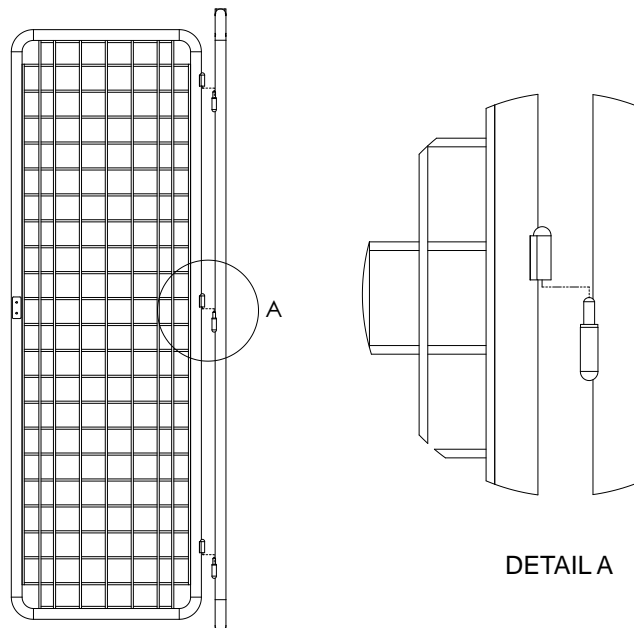

Warranty

GEARGRID Wall Mount Lockers are guaranteed to be free of material and workmanship defects for one full year from the date of purchase.

GEARGRID guarantees to repair or replace defective materials, without charge. To file a claim call our Customer Service department at 888-643-6694. If product return is necessary your Customer Service representative will authorize the return and make arrangements to replace the defective parts.

This is your sole GEARGRID warranty. GEARGRID disclaims all other warranties, including the warranty of merchantability and fitness for a particular purpose, as well as all liability for incidental, consequential, special and indirect damage. GEARGRID liability shall be limited to the amount you paid for the product under warranty. GEARGRID reserves the right to make product changes without obligation to incorporate such changes into products previously sold.

Some states do not allow the exclusion or limitation of damages or warranties, so the above may not apply to you. This warranty gives you specific legal rights. You may also have other rights which may vary from state to state.

GEARGRID products are covered by U.S. patents: 6,241,107; D 636,202; D 635,810

Thank you for choosing GearGrid for smarter, stronger storage solutions.

For your convenience, we've included easy installation instructions for not only the accessories you ordered, but also others available for that unit. Visit www.geargrid.com for a complete roster of handy accessories that can enhance and improve the functionality of your storage unit. You'll also find new ideas for your unique storage applications—from fire, tack and hockey to POP displays and more. Thanks again for choosing GearGrid—everything you need for your toughest storage problems.



670 SW 15th Street | Forest Lake, MN 55025
Phone: 888-643-6694 | 651-464-4468
Fax: 651-464-4780



*Available for 24" wide lockers only

Install the shelf into unit as shown below. The hooks on the shelves get placed over the horizontal wires on the side panels. The left side hook will be placed behind the first vertical side panel wire. The right side shelf hook will be placed in front of the first vertical wire.

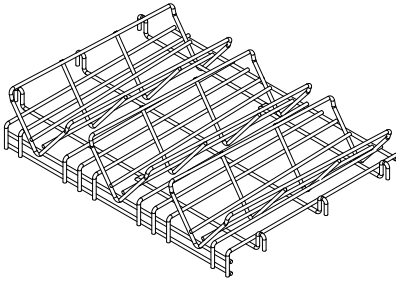

BOTTLE SHELF
QTY - PER ORDER

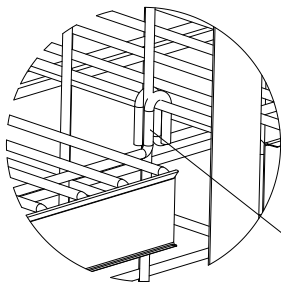
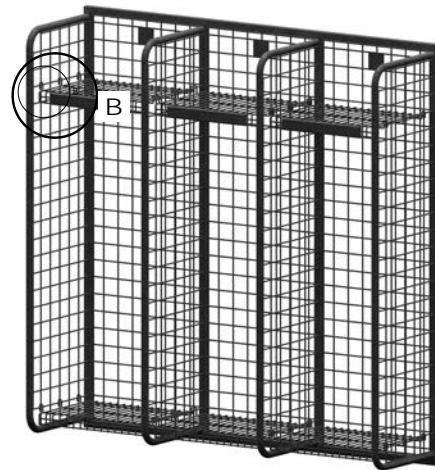
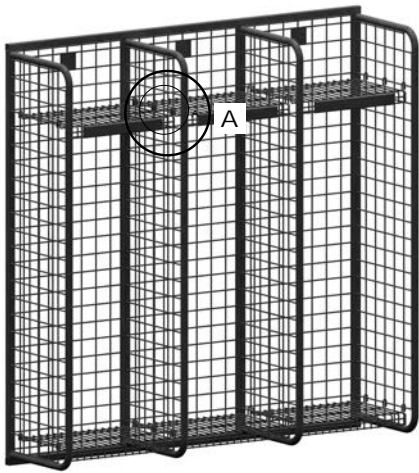

RIGHT SIDE OF SHELF
THE SHELF WIRE GOES IN FRONT
OF FIRST VERTICAL WIRE

DETAIL A

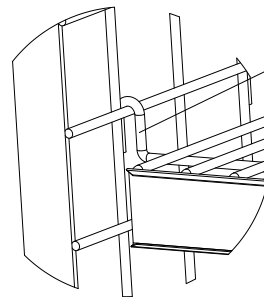

LEFT SIDE OF SHELF
THE SHELF WIRE GOES BEHIND
THE FIRST VERTICAL WIRE

DETAIL B

THANK YOU FOR CHOOSING GEARGRID for smarter, stronger, storage solutions.

670 SW 15th Street, Forest Lake, MN 55025 | Toll Free: 888-643-6694 | 651-464-4468 | Fax: 651-464-4780
sales@GearGrid.com | www.geargridcorp.com

*Available for 18", 20" and 24" wide lockers only

Tools Required:

- 7/16" Wrench
- Phillips Screwdriver

Parts



HANG BAR
QTY - 1

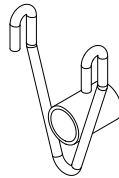

HANG BAR BRACKET
2.25 SPREAD
QTY - 1

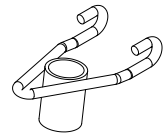

HANG BAR BRACKET
1.625 SPREAD
QTY - 1

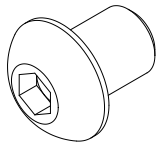

1/4-20 x 1" SCREW
QTY - 2

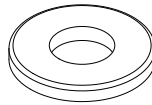

1/4" WASHER
QTY - 4



1/4-20 NUT
QTY - 2

THANK YOU FOR CHOOSING GEARGRID for smarter, stronger, storage solutions.

670 SW 15th Street, Forest Lake, MN 55025 | Toll Free: 888-643-6694 | 651-464-4468 | Fax: 651-464-4780
sales@GearGrid.com | www.geargridcorp.com

GEARHANGER™ Kit Installation

Step 1: Position hang bar as shown in the photos below.



Step 2: Insert screw and washer through bracket and place a washer and nut on the other side to secure bracket as shown in the photo below. Repeat for the other bracket.



For basic step-by-step installation of the Helmet Holder™, there are two wire form components that need to be assembled, an inside piece and an outside piece as shown below.



INSIDE COMPONENT

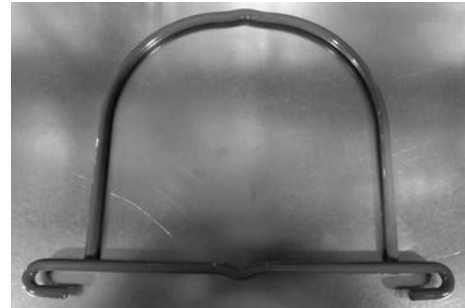

OUTSIDE COMPONENT

Step 1: Place the outside piece on the bottom and set the inside piece in place.

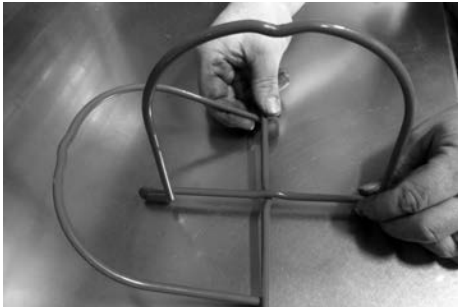

Step 2: Slide the outside piece up and over the inside piece to fit together as shown below.

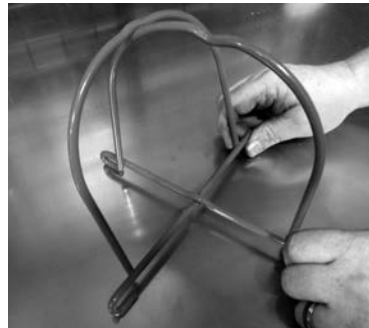

Step 3: Take assembled Helmet Holder™ and squeeze the pieces together to set in position on the shelf.



Step 4: Now spread the pieces back to original form to lock into the shelf.



THANK YOU FOR CHOOSING GEARGRID for smarter, stronger, storage solutions.

670 SW 15th Street, Forest Lake, MN 55025 | Toll Free: 888-643-6694 | 651-464-4468 | Fax: 651-464-4780
sales@GearGrid.com | www.geargridcorp.com

*Available for 24" wide lockers only

Tools Required:

- 7/16" Socket and ratchet
- 1/2" wrench



Parts

- ⑭ BRACKET, L.H.
QTY - 1

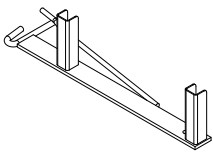

- ⑮ BRACKET, R.H.
QTY - 1

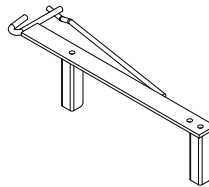

- ⑯ J-HOOK
QTY - 2

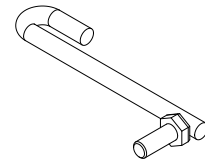

- ⑰ SHELF TUBE
QTY - 2

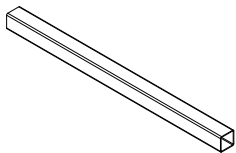

- ⑱ 1/4-20 x 4-1/2" BOLT
QTY - 4

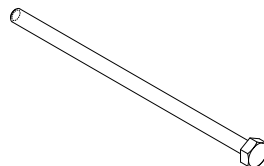

- ⑲ 1/4" WASHER
QTY - 4

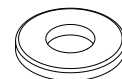

- ⑳ WEDGE NUT
QTY - 4

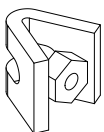

- ㉑ BOOK END
QTY - PER ORDER

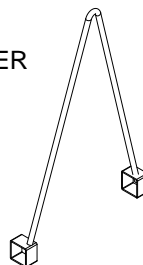

- ㉒ 5/16-18 NYLOCK NUT
QTY - 2

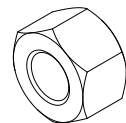

THANK YOU FOR CHOOSING GEARGRID for smarter, stronger, storage solutions.

670 SW 15th Street, Forest Lake, MN 55025 | Toll Free: 888-643-6694 | 651-464-4468 | Fax: 651-464-4780
sales@GearGrid.com | www.geargridcorp.com

Hose Shelf Assembly

Step 1: Locate the following parts from the list:

Part	Description	Quantity
#18	1/4-20 x 4 1/2" Bolt	4
#19	1/4" Flat Washer	4
#20	Wedge Nut	4
#14	Bracket, L.H.	1
#15	Bracket, R.H.	1

Install bolt through the washer and through the outside of the side bracket. Place the wedge nut inside the U-Channel and thread the bolt in. Do this step for both sides, as shown in the photo below. Ensure the orientation of wedge nut is as shown. **Do not tighten bolts at this point.**



Step 2: Locate the following parts from the list:

Part	Description	Quantity
#21	Book End	1
#17	Shelf Tube	2

Slide shelf tubes over the U-Channels on one side of the bracket as shown in the photos below. Next, slide the book end over the shelf tubes with the book end angled in towards the center. Then, install the other bracket side over the other end of the shelf tubes. Push the hose shelf together and tighten the bolts. **Do not over tighten because deformation of the material will occur.**



Hose Shelf Installation

Step 1: Locate the following parts from the list:

Part	Description	Quantity
#16	J-Hook	2
#22	Nylock Nut	2

Install assembled hose shelf by hooking it to the back panel on the unit. Take one J-Hook and a nylock nut and fasten shelf to side panel as shown in the photos below. Install the second J-Hook the same way on the other side of the shelf.



Tools Required:

- 7/16" Wrench

The diagram below shows the SECUREBOX™ installed to the locker side.

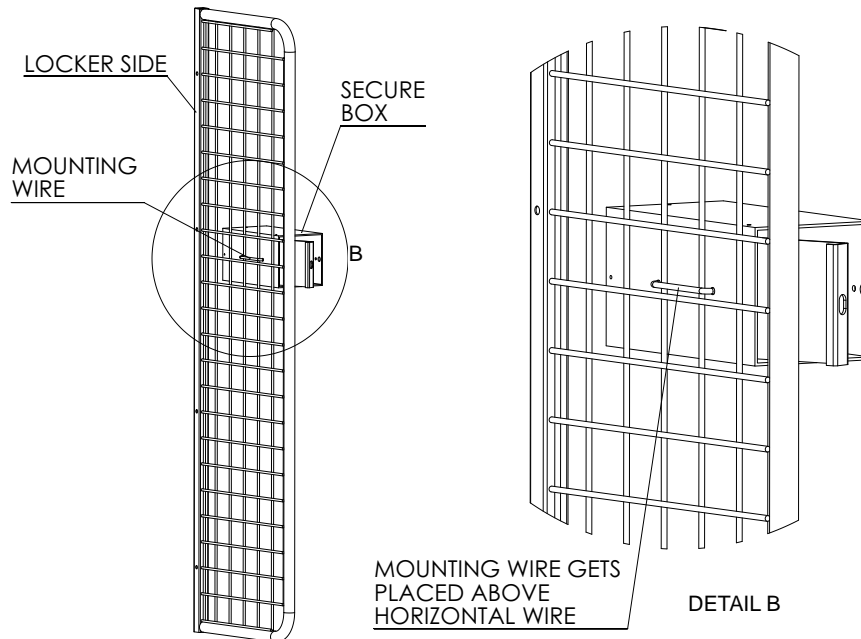

Open the SECUREBOX™ door and unthread the castle nuts from the mounting wire. Next follow the diagram below and position the mounting wire in the desired location you would like the box to be. Guide threaded ends through the holes in the box and thread the castle nuts back on and tighten with a 7/16" wrench.

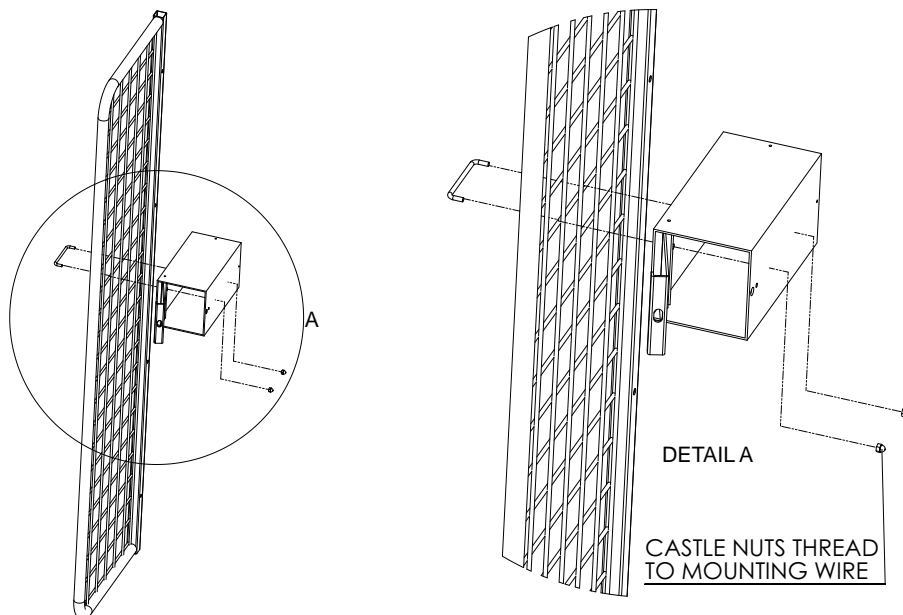

THANK YOU FOR CHOOSING GEARGRID for smarter, stronger, storage solutions.

670 SW 15th Street, Forest Lake, MN 55025 | Toll Free: 888-643-6694 | 651-464-4468 | Fax: 651-464-4780
sales@GearGrid.com | www.geargridcorp.com

*Cannot be used with door option

Tools Required:

- 7/16" Wrench
- 7/16" Socket and ratchet



Step 1: Place seat at desired height with the mounting brackets between the horizontal wires. Place the other side mounting bracket over welded bolt and thread on nut as shown in the photos below.



Step 2: Install the three 1/4-20" by 1" bolts to bracket and install 1/4-20" nuts as shown in the photo below.



THANK YOU FOR CHOOSING GEARGRID for smarter, stronger, storage solutions.

670 SW 15th Street, Forest Lake, MN 55025 | Toll Free: 888-643-6694 | 651-464-4468 | Fax: 651-464-4780
sales@GearGrid.com | www.geargridcorp.com

*Available for 18", 20" and 24" wide lockers only
Cannot be used with door option

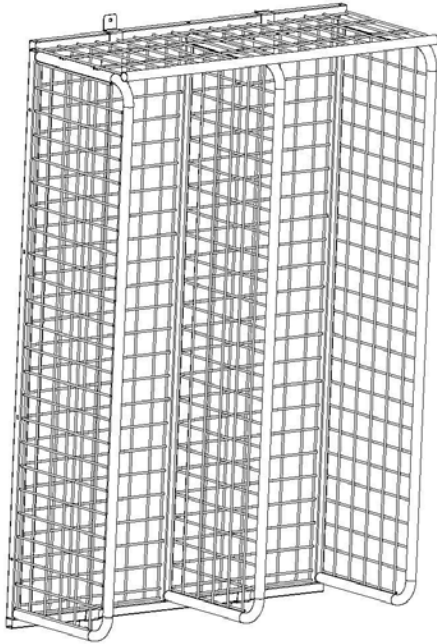

Tools Required:

- 7/16" Wrench
- 7/16" Socket and ratchet

The components below are used for the TOP-SIDE STORAGE™ shelf. They are comprised of two separate parts for many combinations of locker "runs." The TOP-SIDE STORAGE™ start is the component that starts the run on top of the locker system. The TOP-SIDE STORAGE™ extension is the component that mates to the TOP-SIDE STORAGE™ start for extended runs.

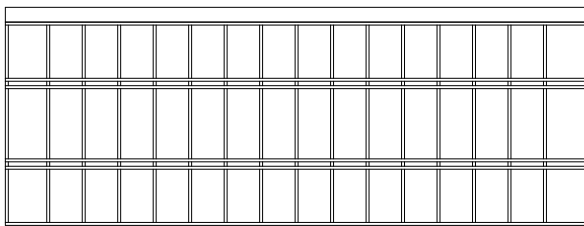

TOP-SIDE STORAGE™ START

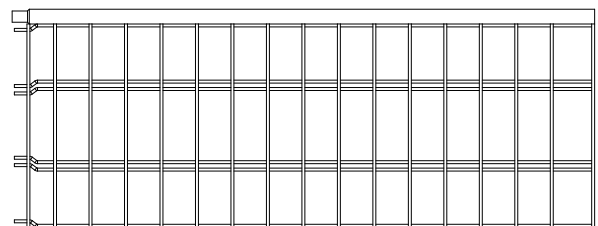

TOP-SIDE STORAGE™ EXTENSION

THANK YOU FOR CHOOSING GEARGRID for smarter, stronger, storage solutions.

670 SW 15th Street, Forest Lake, MN 55025 | Toll Free: 888-643-6694 | 651-464-4468 | Fax: 651-464-4780
sales@GearGrid.com | www.geargridcorp.com

TOP-SIDE STORAGE™ Shelf Installation

Step 1: Place the TOP-SIDE STORAGE™ start on top of the locker with the long wires facing down on the left side of unit. Using the clamps and hardware provided fasten the unit down. There will be four bolts and clamps for one TOP-SIDE STORAGE™ start, two for each end of the unit.

The bolts will go through with a washer on top of double wires and a washer below the long double wires. Fasten with the supplied 1/4" nut and tighten. Use the same hardware for the other side of the start.

Step 2: If a TOP-SIDE STORAGE™ extension was ordered: Install it after the TOP-SIDE STORAGE™ start is installed by sliding the narrow end of the tube into the TOP-SIDE STORAGE™ start tube as shown below. Fasten the right-end down with the clamps and provided hardware per the instructions above.

NOTE: There will only be 2 clamps and bolts with each TOP-SIDE STORAGE™ extension.



Step 3: Insert black plastic plugs provided to cap the tube ends. Check that all clamps are secure to prevent shelf from sliding prior to loading shelf.